



THE ORIGINAL
Equal-i-zer[®]
SWAY CONTROL HITCH
OWNER'S MANUAL

Premium Sway Control Performance



MADE IN THE
U.S.A.

Hitch Ball
Not Included

- 90-00-0600 - 600 lb. max loaded tongue / 6,000 lb. max loaded trailer weight
- 90-00-1000 - 1,000 lb. max loaded tongue / 10,000 lb. max loaded trailer weight
- 90-00-1200 - 1,200 lb. max loaded tongue / 12,000 lb. max loaded trailer weight
- 90-00-1400 - 1,400 lb. max loaded tongue / 14,000 lb. max loaded trailer weight

** Your model # can be found on the stickers on either spring arm. Make a note of it here for future reference **

DEALERS: PLEASE PASS THIS MANUAL ON TO THE
END USER AFTER HITCH INSTALLATION.

www.EqualizerHitch.com

Attention Hitch Owner:

REPLACEMENT

A replacement copy of this manual may be downloaded from www.EqualizerHitch.com or by calling 1-800-478-5578.

KEEP THIS MANUAL

Keep this manual in a safe place as a reference for regular adjustment and maintenance.

FURTHER ASSISTANCE

If you **do not understand** any part of this manual contact a qualified Equal-i-zer[®] hitch dealer in your area or Progress Mfg. Inc. customer service at 1-800-478-5578 or by visiting www.EqualizerHitch.com.

Congratulations on your purchase of The Original Equal-i-zer[®] Sway Control Hitch.

Thank You for your purchase and welcome to the Equal-i-zer[®] hitch family. We appreciate your business and constantly strive to exceed your expectations.

Read this owner's manual thoroughly to become familiar with proper set-up and maintenance procedures to ensure that your Equal-i-zer[®] hitch will give you maximum performance and years of service.

Happy Towing,
The Employees of Progress Mfg. Inc.



Table of Contents

	Page
Parts Breakdown	4
Important Safety Information	6
Important Hitch Information	7
Step 1: Setup Location	9
Step 2: Install the Hitch Ball	9
Step 3: Attach Hitch Head to Shank	10
Step 4: Sway Bracket Assembly Set Up	12
Step 5: Tension Spring Arms	15
Step 6: Weight Distribution Adjustments	17
Step 7: Trailer Angle Adjustments	21
Step 8: Final Tightening	22
Step 9: Regular Maintenance	23
Service Tech Check List	24
Appendix A: Troubleshooting Guide	25
Customer Service	27
Appendix B: Weight Distribution Adjustments	27
Warranty	29

TOOLS NEEDED FOR INSTALLATION

The following tools will allow you to install the hitch properly.

- 1 1/8" Box End Wrench (Shank Bolts)
- 3/4" Box End Wrench (Link Plates and L-brackets)
- 1 1/8" Socket (Shank Bolts)
- 3/4" Socket Wrench (Link Plates and L-brackets)
- 5/8" Socket or Box End Wrench (Angle Set Bolt)
- Measuring Tape
- Pencil
- Torque Wrench capable of 320 Ft-lbs of torque. (Shank bolts)
- Torque wrench capable of 75 Ft-lbs of torque. (Sway Bracket Assembly)

Recommended tools for installing the Hitch Ball:

- 1 7/8" Thin walled socket (available from Progress Mfg. Inc.)
- Torque Wrench capable of 430 Ft-lbs of torque (or higher if hitch ball manufacturer specifies).

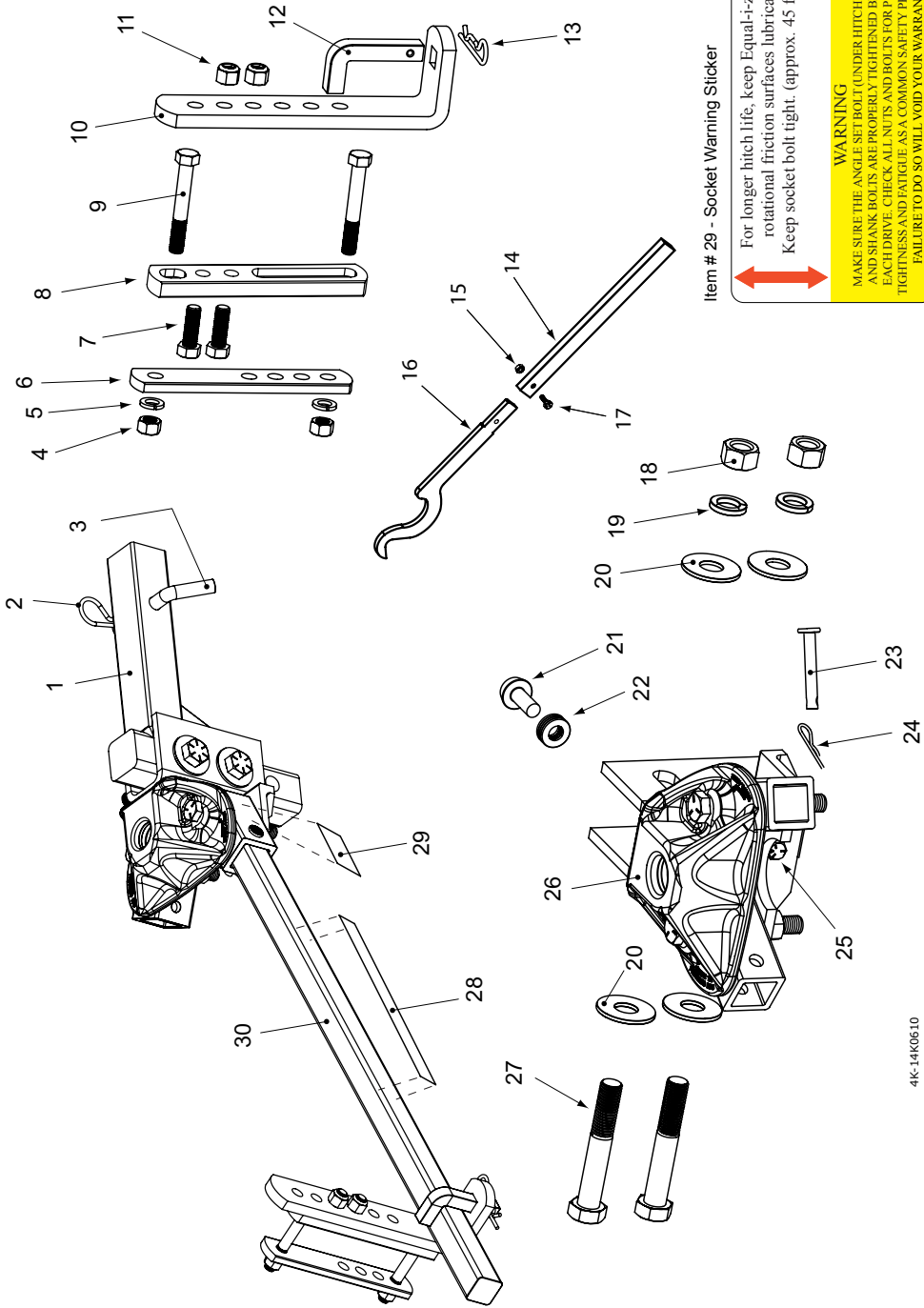

Item # 29 - Socket Warning Sticker



WARNING
 MAKE SURE THE ANGLE SET BOLT (UNDER HITCH HEAD) AND SHANK BOLTS ARE PROPERLY TIGHTENED BEFORE EACH DRIVE. CHECK ALL NUTS AND BOLTS FOR PROPER TIGHTNESS AND FATIGUE AS A COMMON SAFETY PRACTICE. FAILURE TO DO SO WILL VOID YOUR WARRANTY.

90305503

Item #	Part Number	Part Description	Qty.
21	90-03-9105	Spacer Rivet	1
22	90-04-9110	Spacer Washer	6
23	90-03-9212	Socket Pin	2
24	90-04-9216	Socket Pin Clip	2
25	90-03-9700	Angle Set Bolt	1
26	90-02-0600 90-02-1000 90-02-1200 90-02-1400	600 / 6,000 lb. head 1,000 / 10,000 lb. head 1,200 / 12,000 lb. head 1,400 / 14,000 lb. head	1
27	90-04-9131	3/4" x 5" Bolt	2
28	BD064 BD104 BD124 BD144	Arm Warning Stickers 6,000 lb. arm sticker 10,000 lb. arm sticker 12,000 lb. arm sticker 14,000 lb. arm sticker	2
29	BD035	Socket Warning Sticker	2
30*	90-02-0699 90-02-1099 90-02-1299 90-02-1499	6,000 lb. Spring Arm 10,000 lb. Spring Arm 12,000 lb. Spring Arm 14,000 lb. Spring Arm	2

* Each package contains two (2) spring arms. These arms are specifically sized for your hitch head. Spring arms will not function with a hitch head of a different rating.

Item #	Part Number	Part Description	Qty.
1	90-02-4100	Adjustable Shank	1
2	90-04-9224	Hitch Pin Clip	1
3	90-03-9220	Hitch Pin	1
4	90-04-9228	1/2" Nut	4
5	90-04-9290	1/2" Lock Washer	4
6	90-02-5200	Inside Link Plate	2
7	90-04-9281	1/2" x 1-1/2" Bolt	4
8	90-02-5370	Outside Link Plate	2
9	90-04-9270	1/2" x 3-1/2" Bolt	4
10	90-02-5150	L-Bracket	2
11	90-04-9286	Nylock Jam Nut	4
12	90-03-9204	L-Pin	2
13	90-04-9208	L-Pin Clip	2
14	90-03-6200	Snap-up Handle	1
15	90-04-9244	1/4" Snap-up Nut	1
16	90-03-6100	Snap-up Hook	1
17	90-04-9240	1/4" Snap-up Bolt	1
18	90-04-9126	3/4" Nut	2
19	90-04-9120	3/4" Lock Washer	2
20	90-04-9115	3/4" Washer	4

Item# 28 - Spring Arm Warning Sticker

ATTENTION
 IT IS THE OPERATOR'S RESPONSIBILITY TO READ AND USE THE INSTRUCTIONS CAREFULLY TO MAKE THE NECESSARY ADJUSTMENTS TO THEIR PULLING ARM'S TRAILER, TOW VEHICLE, SWAY BAR AND HITCH, INCLUDING PROPER TAILER LOADING REQUIREMENTS, TOWING CONDITIONS, AND OTHERS, TO PREVENT SWAY CONTROL. SWAY CONTROL EXERCISES CAUTION AT ALL TIMES WHILE TOWING. HITCHES ARE RATED BY ALL TOWING LANS.

**4-POINT™
 SWAY CONTROL™**



THE ORIGINAL
Equal-i-zor®
 SWAY CONTROL HITCH

MADE IN THE USA
 Model# 90-00-XXXX
 Max. Tongue Weight ___ Lbs.
 Max. Trailer Weight ___ Lbs.
 V6 & SAE Tested
 Equal-i-zor is a registered trademark of Equal-i-zor Hitch, Inc.
 For a copy of this hitch instruction call
 Progressive Hitch, Inc. at 1-800-468-9078 or visit
www.equalizerhitch.com

Important Safety Information

Failure follow all safety warnings may result in severe injury or death.

WARNING

Read, understand, and follow all safety warnings, setup, use, and maintenance instructions of your trailer, tow vehicle, and hitching equipment before installing your hitch or towing your trailer.

Never cut, weld, grind, bend, or modify hitch components in any way.

It is the drivers responsibility to adjust equipment and driving habits to match towing conditions. The driver is responsible for their own safety and the safety of passengers.

Never exceed the specified weight ratings for the trailer, tow vehicle, hitch, hitch ball, or any other towing equipment.

No hitch setup guarantees that trailer sway will be altogether avoided.

Always load trailer correctly. Follow trailer and tow vehicle manufacturers recommendations for placement and quantity of cargo.

Always tow with a minimum tongue weight of 10% of gross trailer weight.

Always use a hitch ball with a rating that equals or exceeds the trailer Gross Vehicle Weight Rating (GVWR). Always use a hitch ball size that correctly matches your trailer coupler size and make sure it is coupled securely before towing.

Measuring weight distribution setup well does not ensure safe towing. The operator is responsible for making necessary adjustments to the hitch to optimize weight distribution and sway control. Each trip is different, and the weight distribution setup and towing performance should be evaluated by the operator and adjusted when necessary.

Never tow with your hitch adjusted incorrectly.

WARNING

Check all hardware before each trip. Do not tow your trailer until all bolts and nuts have been checked for wear and fatigue, are properly tightened, and all pins and clips are securely in place.

Do not tow your trailer on rough roads. Do not tow your trailer through profound ditches, dips, or swales. Excessive strain on the spring arms and hitch head may cause hitch fatigue or failure.

If your dealer installed your hitch, make sure to verify that it is still adjusted correctly after loading your trailer and tow vehicle for your trip.

Replace worn, faded, or unreadable warning stickers on the spring arms and arm sockets.

Do not transfer hitch to a different tow vehicle or trailer without re-adjusting the hitch for proper weight distribution.

CAUTION

Do not loosen or remove any part of the hitch while the hitch is under load.

Always secure tow vehicle and trailer with parking brake and wheel chocks before setting up or adjusting hitch.

Important Hitch Information

Weight Distribution:

Weight distribution is the ability of a hitch to transfer some of the tongue weight of the trailer from the rear axle of the tow vehicle to the front axle of the tow vehicle, and backward to the trailer axles. Without weight distribution the tow vehicle “teeter-totters” on the rear axle of the tow vehicle, and unweights the front axle. Proper weight distribution transfers weight back to the front steering axle, forcing it back to the ground.

Proper weight distribution also adds performance to the integrated sway control feature of your Equal-i-zer[®] hitch. The Equal-i-zer hitch requires a minimum tongue weight of at least 10% of gross trailer weight. This tongue weight gets distributed, and helps generate the friction needed to reduce trailer sway.

Sway Control:

Integrated sway control is a built-in, patent pending feature of your Equal-i-zer hitch. Once the spring arms are tensioned, the sway control is in force.

Integrated sway control works through the connection between your spring arms and L-brackets, and between the sockets and hitch head. The Equal-i-zer hitch takes advantage of the steel-on-steel friction generated at these points to help reduce trailer sway.

This added friction makes it much more difficult for the trailer to sway side-to-side while its being towed, as is usual when you encounter a gust of wind, or passing semi. When set up well and properly adjusted for your load, the Equal-i-zer can noticeably reduce sway.

Important Setup Information:

These instructions are a guideline to aid in setting up your hitch. Every trailer and tow vehicle combination requires a different setup and adjustment because of factors like trailer weight and length, trailer loading, hitch weight, and tow vehicle suspension and wheelbase. It is not likely that a good setup for one vehicle combination will work well for another. If you change tow vehicle and/or trailer, you should change the hitch setup too.

You must use your best judgment to determine if changes to the setup are required to ensure a safe and comfortable towing situation. There is no all-inclusive formula for setting up or adjusting a hitch that will accommodate each combination of trailer and tow vehicle possible.

The setup may need to be changed slightly at times to accommodate changes in your towing configuration, perhaps even during the same trip. For example, a trailer that starts with full clean water and propane tanks, may tow differently when that water becomes black and grey water, and the propane tanks are empty. Or, a trailer loaded with gear for a long cross country trip may tow differently than the same trailer loaded for a weekend getaway. The driver must be conscious of these changes, and adjust the hitch accordingly.

Step 1 - Set up Location:

Before installing the hitch, the tow vehicle and trailer should be loaded just as they will be while traveling. This includes full propane and fresh water tanks, and any other cargo the tow vehicle (passengers & gear) or trailer will carry, including ATVs for toy haulers. Tow vehicle “auto-level” systems should also be disabled or turned off temporarily.

Park the trailer and tow vehicle on level ground and in line with each other. Chock and uncouple the trailer. Pull tow vehicle ahead about 5 feet to allow working area and set the parking brake.

Take the initial setup measurements for the tow vehicle by measuring from the ground to the top of the wheel wells directly above both the front and back axles of the tow vehicle. See figure 18. Record these on line A of the Weight Distribution Adjustments tables in Step 6.

Measure the FRONT and BACK of the trailer frame, and adjust the trailer to be parallel to the ground. Both FRONT and BACK measurements should be the same.

Step 2 - Install the Hitch Ball:

WARNING

Never exceed the specified weight ratings for the trailer, tow vehicle, hitch, hitch ball, or any other towing equipment.

NOTICE

Using a hitch ball with a shank longer than 2-3/8” may damage hitch and could void your warranty.

Install a properly-sized hitch ball (not included) onto the hitch head. Ball diameter must match trailer coupler size.

Select a ball with a 1-1/4” diameter threaded shank no longer than 2-3/8”. Hitch balls with a longer shank may damage the hitch. If your hitch

ball has a smaller shank you **must** use an appropriate bushing. Make sure that the ball has a weight rating equal to or greater than your trailer's gross vehicle weight rating (GVWR). Always use a lock washer against the nut, unless otherwise specified by ball manufacturer. Torque nut to ball manufacturer's specifications.

Hitch balls require a 1-7/8" socket and a torque wrench capable of approximately 430 Ft-lbs torque for installation. Your nearest Equal-i-zer dealership will have the tools needed and will usually install the hitch ball for a reasonable fee.

Step 3 - Attach Hitch Head to Shank:

With the trailer parallel to the ground, measure from the ground to the top of the trailer coupler.

See Figure 1.

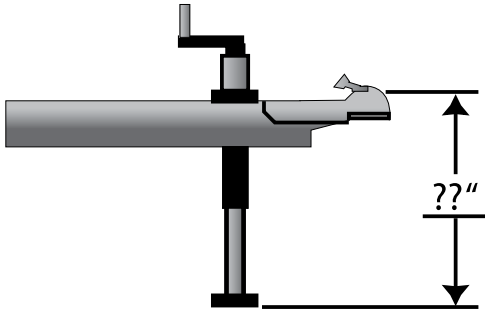

Figure 1

Trailer Coupler Height: _____

The hitch ball should initially be placed as close to this height as possible. Insert the adjustable shank into the receiver on the tow vehicle and secure it with hitch pin and clip.

Insert the spacer rivet with washers into the back of the hitch head to pre-load the angle of the hitch head. Start with 5 spacer washers for longer wheelbase tow vehicles like pickup trucks, and 4 spacer washers with shorter wheelbase vehicles like an SUV. Slide the bolt channel around the shank and hold the hitch head so that the top of the hitch ball measures from the ground as closely as possible to the coupler height. This is generally a step that requires two people.

Observe where the **top slot** in the bolt channel aligns with the holes in the shank. See Figures 2a - 2b. If you can see any part of the shank hole that is lower than the bolt channel slot, drop the head down to align these holes for the initial setup. See Figure 2a. If you cannot see the lower hole in the shank, raise the hitch head so that the top slot aligns with the shank hole slightly above it, and use this hole for the initial setup. See Figure 2b.

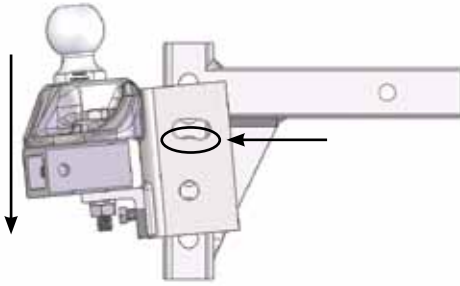

Figure 2a

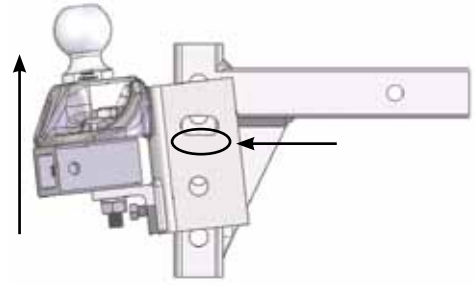

Figure 2b

In some cases, the shank may need to be turned upward, or a specialty length shank may be needed so that the ball can be placed at the correct height. See Figure 3.

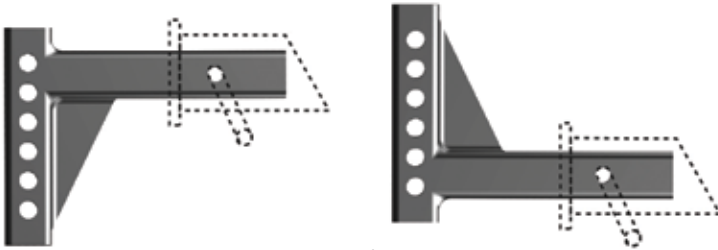

Figure 3

Insert a 3/4" shank bolt with a flat washer through the top slot in the bolt channel and shank hole to hold the head at the correct height. Slide the flat washer, split (lock) washer, then nut onto the other side of the bolt, and hand tighten them. Then repeat this process for the bottom shank bolt. See Figure 4.

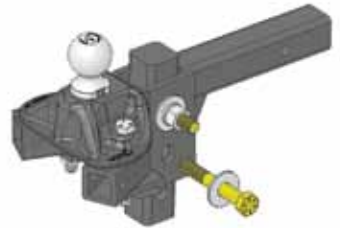

Figure 4

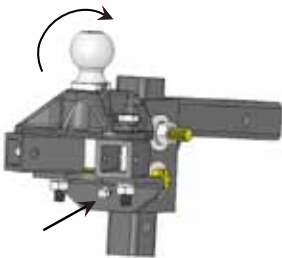

Figure 5

Use a wrench to tighten the angle set bolt until it comes into contact with the shank and lifts the head to where the spacer rivet also comes into solid contact with the shank. Tighten the angle set bolt an additional 1/2 turn. The hitch head should be angled down slightly. See Figure 5.

NOTE: The shank bolts will be fully tightened at the end of the set up and adjustment process.

NOTE: Extended bumper guards, truck campers, or rear mounted spare tires can limit turning radius and may lead to a collision between tow vehicle and trailer in a tight turn unless a longer shank is used. If you are not able to turn tightly with the standard length shank, consult with your dealer about purchasing a longer specialty shank.

Step 4 - Sway Bracket Assembly:

Sway Bracket Location

Measure from the center of the coupler along the outside of the trailer frame, and place a mark at 32" on both sides. This is the center mark for the sway bracket assembly.

Check around the trailer frame and make sure that there are no gas lines, brake lines, or electrical wiring that could be affected by the installation of the link plates. If so, make sure these are re-routed or avoided and will not be disrupted or damaged by the link plate installation.

Placing the brackets at 32" back puts the least amount of stress on the trailer and hitch components, and provides the most comfortable ride. Brackets should be placed at 32" whenever possible. In some cases where there is an obstruction at 32" that cannot be easily moved, like a battery rail or propane tank support, the link plates may be moved forward toward the coupler to a minimum distance no closer than 27" on center. *See figure 6*

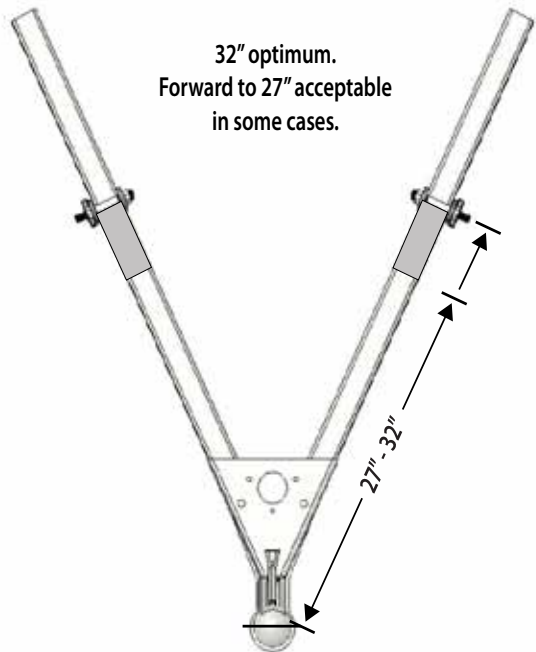

Figure 6

Assemble Link Plates

CAUTION

Do not use impact wrench to tighten link plate or L-bracket bolts.

Insert two 1/2" x 1-1/2" bolts through the outside link plate from the back side. The head of the bolts should fit completely inside the pocket on the back.

Insert one 1/2" x 3-1/2" bolt through the single hole on the outside link plate, and the single hole on the inside link plate. The head of the bolt should fit into the pocket of the outside link plate.

Slide on a split washer, and then thread on the 1/2" nut a few turns. *See Figure 7.*

Identify your coupler style. *See Figure 8.*

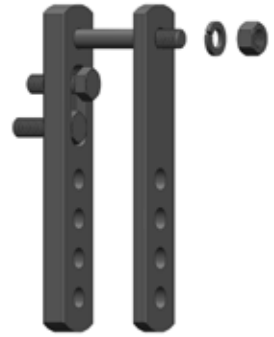

Figure 7

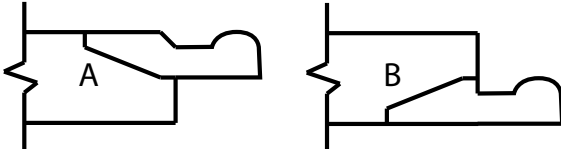

Figure 8

If your coupler is **style A**, drop the link plates over the top of the frame and insert the bottom bolt through the hole closest to the bottom of the trailer frame. Slide on a split washer, then thread a 1/2" nut onto the bolt. *See Figure 9.*

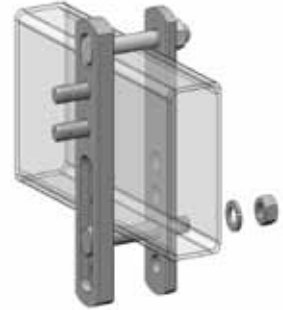

Figure 9

If your coupler is **style B** or if you have a 'V-nose' model trailer, install the link plates *upside down* on

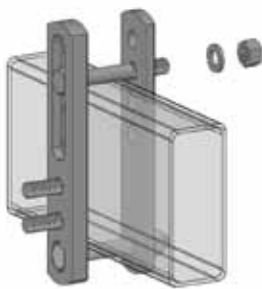

Figure 10

your frame. Slide the assembly up from the bottom. Hold the bolt up tight to the bottom of the frame and thread the top bolt through the link plate hole closest to the top of the trailer frame. Slide on a split washer, then thread a 1/2" nut onto the bolt. *See Figure 10.*

Do not leave any space between the trailer frame and the link plate bolts on the top or bottom of the frame. Move electrical or propane lines if necessary. *See Figure 11.*

	Correct - No Gaps	Incorrect - Gaps Between Frame and Bolt
A style coupler		
B style coupler or V-nose trailer		

Figure 11

Pinch the link plates tight to the sides of the frame and hand tighten the nuts on the inside. See Figure 12a.

Tightening only one nut without first pinching the link plates to the frame may cause the inside link plate to bend when torqued completely. See Figure 12b.

After both nuts are finger tight, use a torque wrench to tighten all link plate bolts to 50 - 70 ft-lbs. torque.

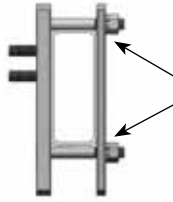
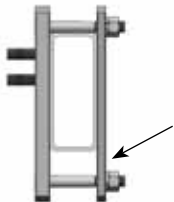
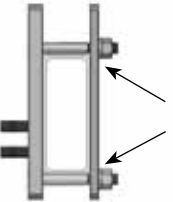
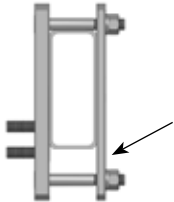
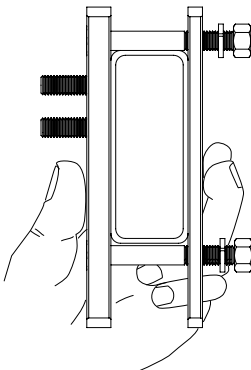

Figure 12a

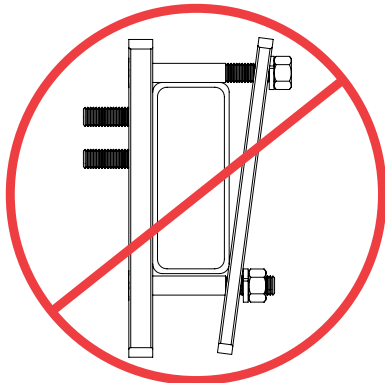

Figure 12b

L-bracket Installation

For the first setup, slide the L-brackets onto the link plate studs with the bend facing away from the trailer. Leave 2 holes showing at the top above the studs and two below. They may need to be adjusted up or down later to get good weight distribution. Thread on the lock nuts and tighten them. *See Figure 13.*

When weight distribution adjustment is complete these nuts should be torqued to between 65 - 75 ft-lbs.

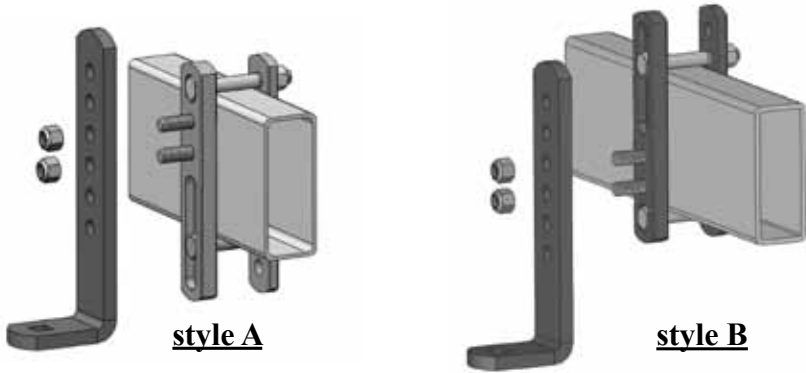

Figure 13

Step 5 - Spring Arm Setup:

! WARNING

Never tow with loose socket bolts. Tighten socket bolts to a minimum of 45 Ft-lbs torque before each towing session.

! CAUTION

Do not pound directly on the sockets to move them. Pounding may cause the sockets to crack or chip. Use only the lever force of the spring arm to move tight sockets. Loosen the socket bolt if required. Re-tighten them once the socket has been moved.

Insert spring arms into the sockets in the hitch head. Arms for the 6K, 10K, and 12K models are not side specific and can be installed on either side of the hitch. Arms for the 14K hitch are notched off center slightly. The arm should be inserted into the socket with the notch on the inside, and with the label facing out.

Insert the socket pin through the hole in the socket and spring arm, and secure it with the socket pin clip. You may need to use the spring arm as a lever to spread the sockets open. This is to allow the spring arms to be lifted and placed onto the L-bracket more easily.

Back tow vehicle to trailer and lower coupler onto ball. Lock the coupler. Continue to retract the tongue jack until it raises off the ground about 1”.

Measure the tow vehicle height again exactly above the axles, to the same point you measured to earlier when uncoupled. Record this on line B of the Weight Distribution Adjustments tables in Step 6.

With the tow vehicle still coupled to the trailer, use the tongue jack to lift both vehicles until you can swing the spring arms into place over the L-brackets. See Figure 14.

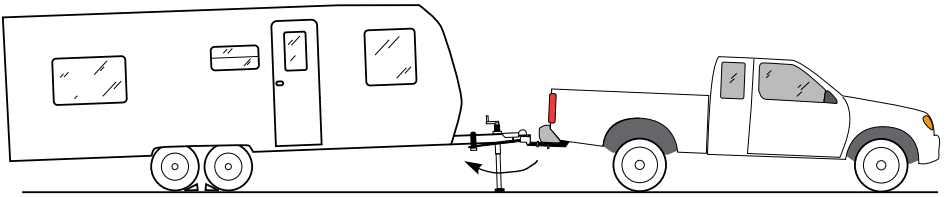

Figure 14

If you reach the top of the jack before the spring arms will swing into position, you can use the Snap-up Lever to lift the spring arms up and onto the L-brackets. Use the L-pins and clips to secure the spring arms on the L-brackets. See Figure 15-16.

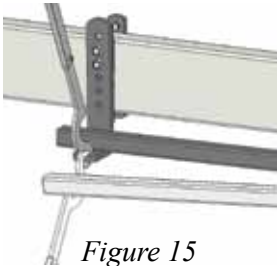

Figure 15

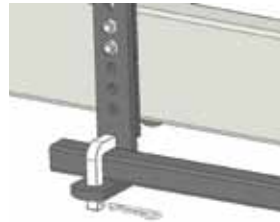

Figure 16

With the spring arms resting on the L-bracket and the trailer and tow vehicle in line with each other, check to make sure that there is a minimum of 3” from the end of the spring arms to the center of the link plates. See Figure 17. Move and re-tighten the link plates if necessary.

Retract the tongue jack until the tongue weight of the trailer settles onto the tow vehicle, and the foot of the jack comes off the ground about 1”.

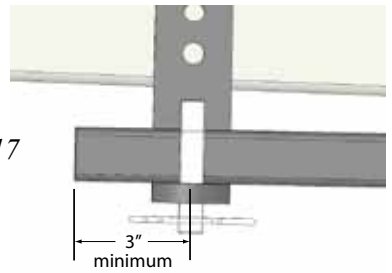

Figure 17

Step 6 - Weight Distribution Adjustments:

Use the following guidelines to set up and adjust your Equal-i-zer for weight distribution. Good weight distribution is a critical component of the Equal-i-zer hitch setup. Every tow vehicle and trailer combination will react differently to weight distribution.

NOTE: Refer to Appendix B “Weight Distribution Adjustments” for a more detailed description of factors that influence weight distribution.

With the trailer coupled and weight distribution engaged, re-measure the tow vehicle heights exactly as done before in Step 1. Record these new measurements on line C of the weight distribution setup tables.

Measure from ground to fender through the center-line of the axle.

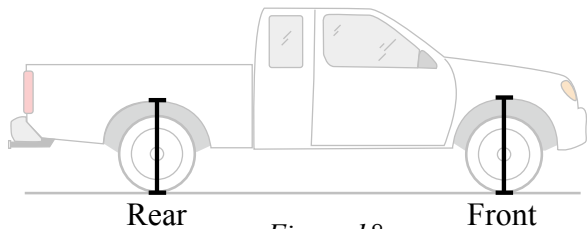

Figure 18

	Rear Wheel Well Height	REAR	Example
A	Tow vehicle loaded for trip but still uncoupled from trailer		29”
B	Tow vehicle coupled but NO weight distribution		26”
C	Tow vehicle coupled with weight distribution engaged. Should be between A and B - never higher than A.		28” Good

Front wheel well height on the next page.

	Front Wheel Well Height	FRONT	Example
A	Tow vehicle loaded for trip but still uncoupled from trailer		28"
B	Tow vehicle coupled but NO weight distribution		30"
Calculate height halfway between A and B $(A+B)\div 2=$			29"
C	Tow vehicle coupled with weight distribution engaged. Should be at least half-way back to A. Higher than this may still be under adjusted.		28"-29" Good
			29"-30" Need More

⚠️ WARNING

Weight distribution is only one of many things that influence sway. The operator is responsible for making necessary adjustments to all contributing factors in order to minimize sway.

Good adjustment:

You have most likely achieved good weight distribution adjustment if your measurements show the following with the trailer coupled and the weight distribution engaged:

1. From the coupled without weight distribution measurement, the front wheel well measurement is at least halfway back to the original uncoupled measurement. *See line C on Front Wheel Well Measure Chart.*
2. The rear wheel well measurement is somewhere between the uncoupled height, and the coupled with no weight distribution height. It should NEVER be higher than the uncoupled height. *See line C on Rear Wheel Well Measure Chart. See Figure 19.*

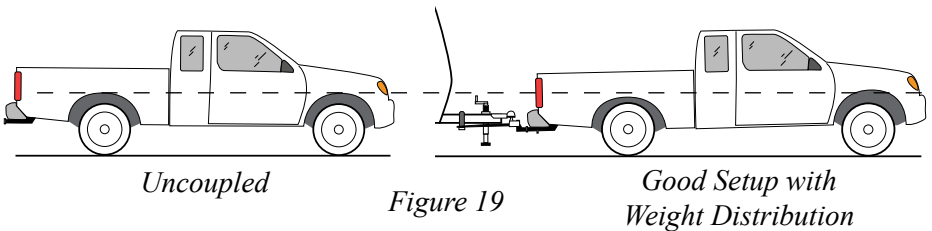

⚠️ WARNING

Over or under adjusted weight distribution decreases tow vehicle stability.

Under or Over Adjustment:

If the hitch is transferring too little or too much weight you must make adjustments to the hitch setup. For changes during the initial setup we recommend adding or removing spacer washers first to try and keep the spring arms parallel with the trailer frame. In our experience, this can help reduce the amount of noise the hitch makes during slow, tight turns. It also gives you more adjustment options if needed later.

Once the maximum (8) or minimum (4) number of spacer washers has been reached, further adjustments can be made by raising or lowering the L-brackets. Minor adjustments later for changes in loading can usually be done by moving only the L-brackets.

NOTE: Tow vehicle wheelbase significantly effects how the tow vehicle reacts to weight distribution adjustments. Shorter tow vehicles move farther up or down than longer ones with the same washer or L-bracket change. You may not notice much movement at all in the front end of a long tow vehicle, while a short tow vehicle may raise or drop significantly.

Under adjustment occurs when there is not enough weight being transferred to the front axles of the tow vehicle. *See Figure 20.*

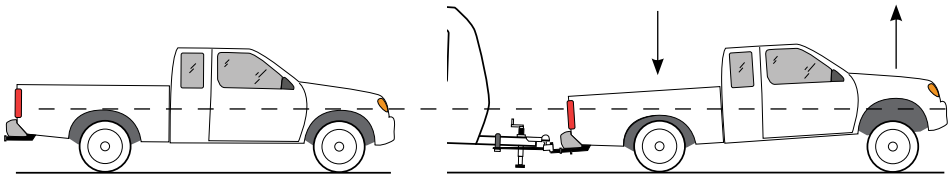

Figure 20

You most likely need more weight distribution adjustment if your measurements show that from the coupled without weight distribution measurement, the front wheel well measurement is **STILL HIGHER THAN** halfway back to the original uncoupled measurement. *See line C on Front Wheel Well Measure Chart.* With an under adjusted setup your hitch is not giving back as much steering control as it could, nor is it providing as much friction as it could to help reduce trailer sway.

To correct under adjustment you must add more weight distribution force to the hitch by adding spacer washers, or raising the L-brackets.

If this is the initial set up, use the tongue jack to unload the spring arms. Remove the spring arms from the hitch head. Uncouple the trailer and pull tow vehicle forward. Loosen the angle set bolt and *add* a spacer washer. Repeat step 5 and 6 to re-adjust and check weight distribution.

If you have reached the maximum number of spacer washers, or if adjusting temporarily due to a change in vehicle loading, use the tongue jack to unload the spring arms. *Raise* the L-brackets 1 hole. Move the spring arms back over the L-brackets and retract the tongue jack. Re-measure the wheel wells and check for proper weight distribution.

Repeat Steps 5 and 6 until the measurements show that the hitch is distributing weight well.

Over adjustment occurs when there is too much weight being transferred to the front axles of the tow vehicle. *See Figure 21.*

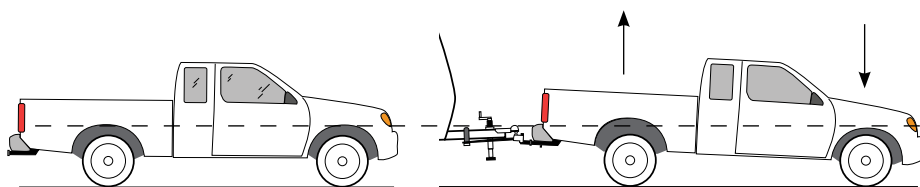

Figure 21

You most likely need less weight distribution adjustment if your measurements show that from the coupled without weight distribution measurement, the rear wheel well measurement is **HIGHER** than the original uncoupled measurement. *See line C on Rear Wheel Well Measure Chart.*

Over adjustment is a very dangerous situation where loss of control and jack-knifing is possible, especially in wet or slick road conditions.

Over adjustment is more likely to occur when towing with a very short wheelbase vehicle like an SUV. To correct over adjustment you must take some of the weight distribution force out of the hitch by removing spacer washers, or lowering the L-brackets.

If this is the initial set up, use the tongue jack to unload the spring arms. Remove the spring arms from the hitch head. Uncouple the trailer and pull vehicle forward. Loosen the angle set bolt and *remove* a spacer washer. Repeat Steps 5 and 6 to re-adjust and check weight distribution.

If you have reached the minimum number of spacer washers, or if adjusting temporarily due to a change in vehicle loading, use the tongue jack to unload the spring arms. *Lower* the L-brackets 1 hole. Move the spring arms

back over the L-brackets and retract the tongue jack. Re-measure the wheel wells and check for proper weight distribution.

Repeat Steps 5 and 6 until the measurements show that the hitch is distributing weight well.

Step 7 - Trailer Angle Adjustment:

After achieving a good weight distribution setup you may need to adjust the attitude (angle) of the trailer. Step back and look at the trailer to see if the front appears to be tipped up or down excessively.

Measure the FRONT and REAR of the trailer again at the same points you did when setting the trailer parallel to the ground in Step 1. Record these measurements on the *Trailer Attitude Adjustment chart*.

Find the difference between the highest and lowest heights.

Trailer Attitude Adjustment chart	
Front Measurement	
Back Measurement	
Difference between highest and lowest	

If the difference between the highest and lowest measurement is 1-1/4" or more, you should try adjusting the hitch ball height. If it is less than 1-1/4" different, complete Step 8 and tow a short distance with this setup to see how it handles before making any adjustments.

If the *higher* measurement is the front of the trailer, move the hitch head down 1 hole position on the shank. If the *lower* measurement is the front of the trailer, move the hitch head up 1 hole position on the shank.

Adjustments made to ball height affect how weight is distributed. Moving it up slightly reduces the amount of weight distribution you get from a particular setup. Moving it down slightly increases the weight distribution from that same setup.

After making an adjustment to the ball height, return to Step 6 and check the weight distribution measurements again. Re-adjust the weight distribution if necessary until it falls within the instruction guidelines. Re-check the trailer angle again to see what difference has been made. You may need to try several setups before you get one that shows good weight distribution and trailer angle.

Step 8 - Final Tightening:

WARNING

Do not tow your trailer until all bolts and nuts have been checked and properly tightened, and all pins and clips are securely in place.

After you have made proper adjustments to the hitch to give your setup good weight distribution and trailer angle, all bolts on the hitch must be tightened completely.

Use your tongue jack to lift the trailer and tow vehicle, and disconnect the spring arms. Lower the tongue jack and uncouple the trailer from the tow vehicle. Pull the tow vehicle forward a few feet to give yourself working room to tighten the hitch bolts.

Remove the pins and clips from the spring arms, and remove the spring arms from the hitch head. Remove the hitch pin and clip. Slide the hitch head and shank from the receiver, turn the assembly upside-down, and place it back into the receiver tube. Replace the hitch pin to secure it temporarily.

Use the torque wrench to tighten both 3/4" shank bolts to 320 Ft-lbs. Use the adjustable wrench to snug the angle set bolt to the shank again if needed. Do not over-tighten the angle set bolt.

Double check the nuts holding the L-brackets to make sure they are torqued to between 65 and 75 Ft-lbs. Check that all link plate bolts are tightened to between 50 and 70 Ft-lbs.

Remove the hitch pin, and return the head and shank to the upright position. Replace the spring arms, and secure them with the socket pins and clips. Couple the trailer again to the tow vehicle, and put the spring arms back in place on the L-brackets. Secure each with an L-pin and clip.

You are now ready to take the trailer out for a tow. Remember to connect the safety brake cable, safety chains, and electrical cables. Make sure your trailer brake control is correctly adjusted. Retract the jack completely. Tow carefully at first and pay attention to how it feels. Follow the ***Troubleshooting Guide in Appendix A*** which suggests ways that can help improve your towing experience if needed.

Step 9 - Regular Maintenance:

The friction surfaces of the head and sockets should be kept clean and well lubricated with a good quality lubricant. They should be lubricated before each trip. Check for damage or abnormal wear at the beginning of each towing day and replace if necessary. Use a rag to clean dirt and road grit from all friction surfaces regularly.

All nuts and bolts should be checked before each towing day and re-tightened or replaced if necessary.

⚠️ WARNING

Towing with loose bolts for an extended period of time can cause abnormal stress on the hitch resulting in accident, severe injury, and property damage. Shank bolts must be torqued to 320 Ft-lbs

Pay special attention to the angle set bolt. There is a break-in period for each hitch and towing configuration. This period is not the same for every towing configuration. With use, the spacer washers and rivet may compact slightly leaving a small gap between the angle set bolt and the shank. The bolt should be checked carefully every 100 miles for the break-in period and re-tightened as explained in Step 8. You will notice that over time the need to re-tighten the angle set bolt will diminish, but you should still check it regularly before each towing day as part of your hook-up routine.

Store your hitch out of the weather when not in use. Keep it clean and free from rust. From time to time, use a good quality rust inhibiting spray paint to touch up the finish and keep it looking good. Do not paint over the warning stickers. If the warning stickers become worn or unreadable, contact Progress Mfg. Inc. for free replacement.

Service Tech and Experienced Installer Check List

Step 1	
	Have your loaded tow vehicle and trailer on a level surface.
Step 2	
	Install the hitch ball. If already installed, check that the ball is in good condition and is tight on the head.
Step 3	
	Measure from the ground to the trailer coupler. (step 6)
	Insert the adjustable shank into the receiver and secure it with the hitch pin and clip.
	Insert the spacer rivet with washers into the back of the hitch head to pre-load the angle of the hitch head.
	Slide the hitch head bolt channel around the shank and hold the hitch head so that the top of the hitch ball measures from the ground as close as possible to the coupler height. (step 3)
	Insert the shank bolts, washers, and nuts to attach the head to the shank. Tighten the angle set bolt.
Step 4	
	Measure 32" from the coupler on the trailer frame. The sway bracket centers should be installed between 27"-32" on the trailer frame.
	Determine what coupler style (A or B) you have before installing the sway brackets.
	Install the sway control brackets.
	Ensure the link plates are flat against the trailer frame.
Step 5	
	Lift hitch bars onto the L-bracket.
	Retract tongue jack until the weight of the trailer rests on the tow vehicle.
Step 6	
	Use Step 6 to check for good weight distribution and make needed adjustments.
Step 7	
	Use Step 7 to check the trailer angle and make adjustments.
Step 8	
	Check that all bolts and nuts have been properly tightened and that all pins and clips are securely in place.
Step 9	
	Keep your hitch clean and lubricated.
	Give Owner's Manual to customer.

Appendix A

Troubleshooting Guide

Problem	Possible Cause	Suggested Correction
Trailer Sway	Not enough weight distribution	Follow “under adjustment” guidelines to add spacer washers or raise L-bracket.
	Tongue weight too light	Weigh loaded trailer and tongue weight. Tongue weight should be a minimum of 400lbs., and usually between 10%-15% of Gross Trailer Weight. Follow trailer mfg. guidelines for tongue weight. Reposition load in trailer as needed. Remove cargo carriers or 2nd trailer from rear of trailer.
	Incorrect Tire Pressure	Check and fill tires as needed to mfg. recommendations.
	Socket bolts loose	Make sure socket bolts are tightened to between 45-65 Ft-lbs torque.
	Tow capacity exceeded	Make sure your tow vehicle is rated to tow your trailer’s tongue weight and Gross Vehicle Weight. If it’s not, DO NOT TOW.
	Hitch Undersized	Check to make sure your hitch rating meets or exceeds both your Gross Trailer Weight Rating and Max Tongue Weight. If it does not, DO NOT TOW. Purchase an Equal-i-zer hitch with a higher rating.
Tow Vehicle Too High in Front	Not enough weight distributed	Follow “under adjustment” guidelines to add spacer washers or raise L-bracket.
Front End Feels “Floaty”	Not enough weight distributed	Follow “under adjustment” guidelines to add spacer washers or raise L-bracket.

Trailer is Too Low or Too High in Front (More than 1-1/2" from level)	Improper hitch ball height	Follow Step 7 - Trailer Angle Adjustment section to change ball height.
	Improper hitch ball height because shank is too short	Consult your local Equal-i-zer hitch dealer about using a specialty length shank.
Bent or broken L-bracket, L-pin, or Link Plate	Link plates installed too far back from hitch ball center	Follow Step 4 and set center of link plates between 29"-32" from the center of the coupler.
"Walking" Sway Bracket Assembly	Link plates under-tightened	Follow Step 4 to tighten link plates correctly.

Noise:

In some cases the friction on the L-brackets or sockets also generates noise. This most commonly occurs during slow, tight turns where the tow vehicle and trailer are in a twist. This noise is normal and should be expected. It is an indication that there is friction on the L-bracket and sockets. Most of the noise will usually subside after a few uses as the hitch breaks in. Trailer and tow vehicle loading may also influence hitch noise.

Lubricating the socket joint may help reduce this noise, and is part of the required regular maintenance routine. Lubricating the L-bracket joint is optional. A better solution is a set of official Equal-i-zer brand Sway Bracket Jackets. They quiet the ride without the mess of using a lubricant.

Customer Service:

For customer service, replacement parts, and accessories we recommend that you visit your local dealership that is familiar with Equal-i-zer® brand products whenever possible. If at any time you need customer service and are unable to reach a dealership, please call our toll free customer support line at 1-800-478-5578, or visit us online at www.equalizerhitch.com.

Appendix B

Weight Distribution Adjustments:

You should carefully consider the following items and their effects when setting up initially and when adjusting your hitch before each trip:

- **Vehicle wheel base:** Shorter wheelbase vehicles react farther and faster than longer wheelbase vehicles to weight distribution adjustments.
- **Vehicle suspension:** Soft suspensions, such as an SUV will react farther and faster to weight distribution adjustments than stiff suspensions like a 3/4 ton pickup. For a smoother ride, some vehicle suspensions are designed to be very soft with the first few pounds of payload, and to then stiffen as the load increases. This means that initially the springs move a long way with very little weight applied, then later move much less, even with a significant change in applied weight.
- **Trailer length:** Longer trailers will try to force distributed weight forward to the tow vehicle before absorbing it into the trailer suspension. Shorter trailers absorb more of the distributed weight into their suspensions.
- **Tongue weight:** To operate effectively, your tongue weight should be at least 10% of the gross trailer weight. This helps provide the sway resisting friction force on the L-brackets and head sockets of the hitch that give it the ability to resist movement and thus to resist trailer sway.
- **Trailer loading:** This is one of the most significant factors that influences trailer sway. Most trailers are designed to have a tongue weight of between 10% and 15% of the overall trailer weight. Always follow the trailer manufacturer's guidelines for tongue weight. Trailers that are "back-end heavy" can often cause trailer sway. Trailer loading

changes tongue weight dramatically, and loading can change dramatically from one trip to the next, or even during the course of a short weekend trip.

For example; full water and propane tanks that are tongue weight when you leave can become full waste tanks that subtract tongue weight for the return trip. Shifting just 40 gallons of water from the front to the back of your trailer can change 330 lbs. of positive tongue weight to 330 lbs. of negative tongue weight. Toy haulers without toys are designed to have very heavy dry (empty) tongue weights so that when they are loaded with toys they become a more balanced load.

Cargo carriers, bike racks, and second trailers attached to the rear bumper of a trailer add weight to the rear of the trailer that automatically subtracts tongue weight. We recommend that you do not add weight of any form to the rear bumper of your trailer. We also recommend that you do not tow a 2nd trailer under any circumstance.

- Trailer coupled attitude: Attitude refers to the angle that the trailer is tipped to. It is generally accepted that a trailer should be towed sitting parallel to the ground, or with the front (coupler) tipped slightly down. The front tipped too far up or down may be an indication of improper trailer loading, or a need to adjust the ball height or weight distribution settings.
- Vehicle weight ratings: Each trailer and tow vehicle has a maximum Gross Vehicle Weight Rating (GVWR). Never exceed these ratings. The tow vehicle and towing equipment, including receiver, shank, hitch, and hitch ball all have maximum weight ratings for tongue weight and trailer weight. Never exceed any of these ratings.

Check your trailer and tow vehicle axle weight ratings. Never exceed trailer or tow vehicle axle weight ratings.

Warranty

Limited Lifetime Warranty: Progress Mfg. Inc. warrants the Equal-i-zer® hitch against latent defects in materials and workmanship under normal use and service, ordinary wear and tear is excepted, from the first date of purchase at retail for the ownership life of the original purchaser. If this product is latently defective it will be replaced or repaired when a proper return authorization is obtained and the product is returned with transportation charges prepaid to the Progress Mfg. Inc. manufacturing plant. Progress Mfg. Inc. shall not be required to replace or repair any products damaged as a result of improper installation, alteration, unreasonable use, or improper maintenance including, without limitation, loading the product beyond the factory rated load capacity. This warranty does not include labor charges nor does it include transportation charges for returning the product to the consumer. To the extent allowed by law, Progress Mfg. Inc. shall not be liable for any incidental, consequential, or any other damages including, without limitation, breach of any implied warranty, merchantability, or fitness for a particular purpose of any Equal-i-zer product. In no event shall Progress Mfg. Inc. be liable for any damages other than the replacement or repair of the affected part. Authorization and warranty procedure may be obtained by calling Progress Mfg. Inc. customer service at 1-800-478-5578.

To register your hitch online visit: www.equalizerhitch.com

NOTES

More great towing products from Progress Mfg.

flip
automatic
jack foot

- No more wood blocks to stack or store
- Adds 6" instantly
- Puts itself away
- No pins to pull or insert
- No bending over or kneeling down



Visit: www.FastwayTrailer.com

The Fastway® Zip™ breakaway cable's coiled design keeps your cable from dragging!



Progress Mfg. Products and Accessories

THE ORIGINAL
Equal-i-zer[®]
SWAY CONTROL HITCH



High Performance Lubricant

Easy application tube lets you put just the right amount of lubricant right where you need it without making a mess. Great for hitch ball and arm socket applications.



Replacement Pins & Clips

OEM replacement pins and clips come in a convenient clamshell package. Keep an extra set on hand just in case. Parts available include: L-pins, Socket pins, hitch pins, and clips.

Visit: www.EqualizerHitch.com

FASTWAY

The Fastway[®] ONEstep[™] is convenient and easy to use. Simply step down on the scissor arms to firmly lock your trailer in place, and lean the cable against the tire. To remove pull up on the cable and the chock slides right out. Center pin design quickly adjusts the chock from 16" to 24" to fit most tandem axle trailers. Great for travel trailers, 5th wheels, boats, cargo and horse trailers.



ONEstep[™]
tandem axle wheel chock

Visit: www.FastwayTrailer.com

To register your hitch online visit: www.equalizerhitch.com

The Equal-i-zer[®], and Fastway[®]
are products of



533 S. 500 W. • Provo, UT 84601 • (800) 478-5578

www.progressmfg.com

All printed material copyright © 2010 Progress Mfg. Inc. - All rights reserved.